



SKY-0322-A

R32



SkyAir

Single-Split Inverter & Non Inverter Series

www.daikin.com.my

DAIKIN MALAYSIA SALES & SERVICE SDN. BHD.

Head Office: Tel: 03-7953 8388 Fax: 03-7956 4371
Email: sales_enquiry@daikin.com.my, customer_service@daikin.com.my

- Branches:
- Kedah Tel: 04-730 5670
 - Penang Tel: 04-331 1670
 - Perak Tel: 05-548 2307
 - Negeri Sembilan Tel: 06-768 8969
 - Melaka Tel: 06-288 1133
 - Johor Tel: 07-557 7788
 - Pahang Tel: 09-567 6778
 - Kelantan Tel: 09-747 4578
 - Sabah Tel: 088-722 194
 - Sarawak Tel: 082-333 299

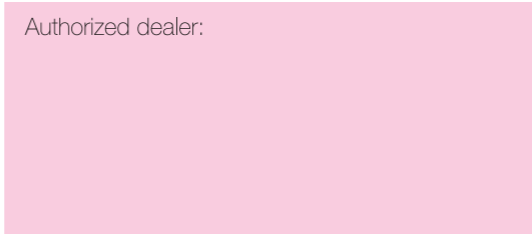

Catalogue No. PLXDSMY1856



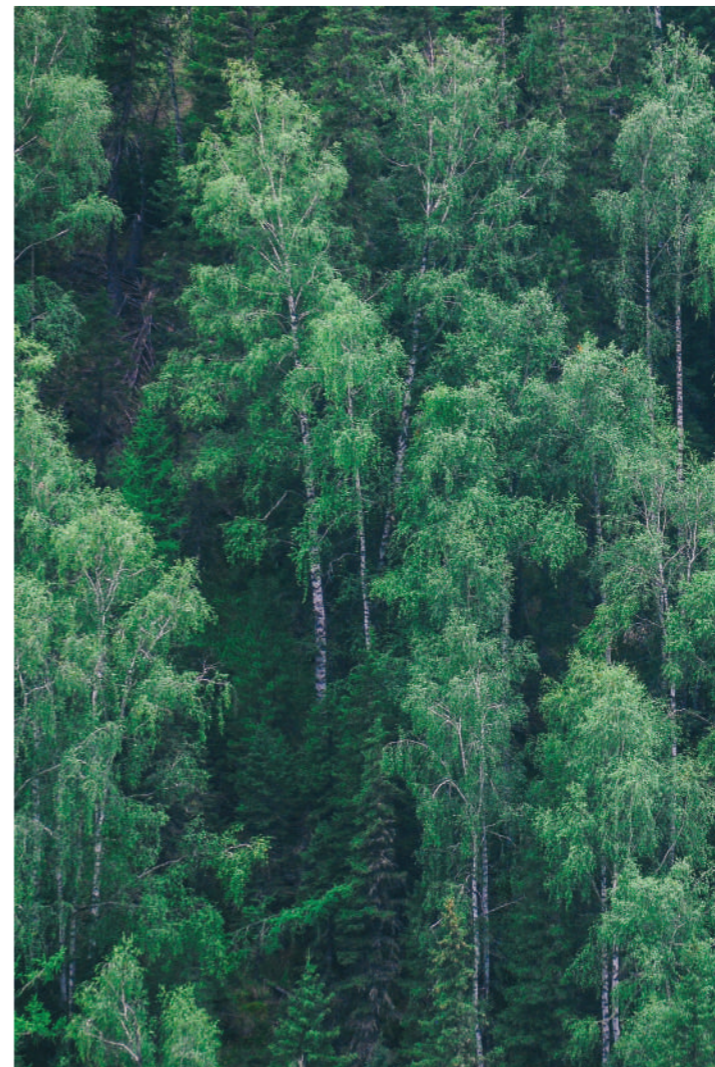

R32

The Superior Refrigerant

This game changing refrigerant strikes the perfect balance between energy efficiency, ease of use and environmental sustainability; offering distinct advantages across the board. Bringing you comfort and a peace of mind.

Less Impact On Global Warming

The earth retains solar heat in the daytime for warming and then releases this heat at night, allowing it to maintain an optimal temperature range. However, with greenhouse gases increasing, it is more difficult to discharge heat and the planet is gradually becoming warmer. This is called global warming. R32 has only around 30% of the global warming potential of R410A and R22.

	Ozone Depletion Potential	Global Warming Potential
R32	0	675
R410A	0	2,090
R22	0.05	1,810

R32 has zero Ozone Depletion Potential (ODP), and lower Global Warming Potential (GWP) which contributes to the prevention of global warming.

Lesser Refrigerant Charge

Potential refrigerating effect of R32 is 1.5 times that of R22 or R410A. More specifically, pressure losses are lower with R32 than R22 or R410A for the same capacity and the liquid density of R32 is also 10% lower. As a result, the charging volume for R32 is approximately 30% less than that of R410A and R22.

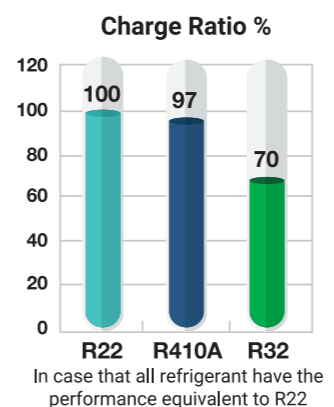

Easy Maintenance and Serviceability

Unlike R410A and R407C, which are mixed refrigerants, R32 is a Single component refrigerant. This means that no composition change occurs, and likewise R22, allows for easy liquid charge and gas charge.







	Composition (Mixture ratio wt%)
R32	Single Component
R410A	R32/R125 (50/50 WT%)
R22	Single Component

Inverter Series

	25	35	50	60	71
Ceiling Cassette Smart Control Indoor Unit			 FCFC50AV1MF	 FCFC60AV1MF	 FCFC71AV1MF
Ceiling Concealed Middle Static Pressure Type Indoor Unit			 FDMFC50AV1M	 FDMFC60AV1M	 FDMFC71AV1M
Outdoor Unit			 RZFC50AGVMM	 RZFC60AGVMM	 RZFC71AGVMM
Power Supply			Outdoor 220-240v / 1 Phase / 50Hz	Outdoor 220-240v / 1 Phase / 50Hz	Outdoor 220-240v / 1 Phase / 50Hz

Non-Inverter Series

	25	35	50	60	71
Ceiling Cassette Type Indoor unit	 FFC25AV1M	 FFC35AV1M	 FCC50AV1M	 FCC60AV1M	
Ceiling Concealed Low / Middle Static Pressure Type Indoor unit	 FDBC25AV1M	 FDBC35AV1M	 FDMC50AV1M	 FDMC60AV1M	
Ceiling Exposed Type Indoor unit			 FHC50AV1M	 FHC60AV1M	
Outdoor Unit	 RC25BV1M	 RC35BV1M	 RC50BV1M	 RC60BV1M	
Power Supply	Indoor 220-240v / 1 Phase / 50Hz	Indoor 220-240v / 1 Phase / 50Hz	Indoor 220-240v / 1 Phase / 50Hz	Indoor 220-240v / 1 Phase / 50Hz	

	85	100	125	140	160
Ceiling Cassette Indoor Unit	 FCFC85AV1MF	 FCFC100AV1MF	 FCFC125AV1MF	 FCFC140AV1MF	
Ceiling Concealed Middle Static Pressure Type Indoor Unit	 FDMFC85AV1M	 FDMFC100AV1M	 FDMFC125AV1M	 FDMFC140AV1M	
Outdoor Unit	 RZFC85AVMM	 RZFC100AVMM	 RZFC125AY1M	 RZFC140AY1M	
Power Supply	Outdoor 220-240v / 1 Phase / 50Hz	Outdoor 220-240v / 1 Phase / 50Hz	Outdoor 380-415v / 3 Phase / 50Hz	Outdoor 380-415v / 3 Phase / 50Hz	

	85	100	125	140	160
Ceiling Cassette Type Indoor unit	 FCC85AV1M	 FCC100AV1M	 FCC125AV1M	 FCC140AV1M	
Ceiling Concealed Low / Middle Static Pressure Type Indoor unit	 FDMC85AV1M	 FDMC100AV1M	 FDMC125AV1M	 FDMC140AV1M	 FDMC160AV1M
Ceiling Exposed Type Indoor unit	 FHC85AV1M	 FHC100AV1M	 FHC125AV1M	 FHC140AV1M	 FHC160AV1M
Outdoor Unit	 RC85BV1M	 RC100BV1M	 RC125BY1M	 RC140BY1M	 RC160BY1M
Power Supply	Indoor 220-240V / 1 Phase / 50Hz	Outdoor 220-240V / 1 Phase / 50Hz	Outdoor 380-415V / 3 Phase / 50Hz	Outdoor 380-415V / 3 Phase / 50Hz	Outdoor 380-415V / 3 Phase / 50Hz

Stay In Control. No Matter Where You Are.



Smart Control



GO DAIKIN

Smart Control

Simplify your life with the GO DAIKIN application. The GO DAIKIN application lets you manage Daikin air conditioners from anywhere, helping to maintain a comfortable home environment while saving energy.

An application that easily allows for the control of your home climate! With just a simple wifi connection, you can now create the perfect climate for your home.

GO DAIKIN

In-Home & Out-Of-Home Function Allows You To Control Your AC At Anywhere Anytime.

- GO CONVENIENCE**
 - In-home & Out-of-home function allows you to control your AC at anywhere anytime.
 - Weekly scheduling allows you to set your AC at your preferred timing at a weekly basis.
- GO SAVE**
 - Greater savings can be achieved as you can now smartly monitor your AC energy consumption!
 - *Inverter models will be able to view in kW and estimated monetary value while Non-Inverter to view compressor running hours only.
- GO COMFORT**
 - Different operational modes allows you to enjoy the different kinds of cooling experience.
- GO SHARE**
 - User control sharing easily allows you to share your AC controls with your family members through a simple QR code scanning.
 - You can unbind the controls or restrict certain app functions of the AC from your family members at any time you desire.



Restaurant

Weekly Scheduling⁴ allows for systematic switching on and off of Air Conditioner at specific times throughout a restaurant's daily and weekly operation, thus removing the repetitive actions of physically using the remote controller every time.



GO DAIKIN



University

Real Time Monitoring helps university building management to understand and monitor live feedback of Air Conditioner status (including on / off status, set temp and error code etc), which enables them to oversee and control the overall A/C usage.

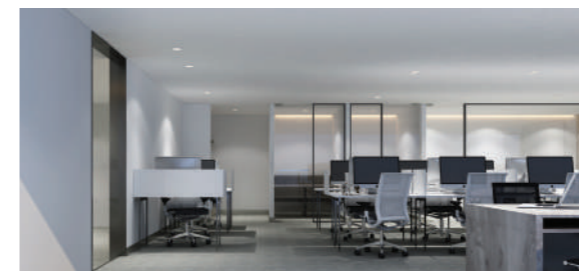

Office

Group Control grants office admins the power to control multiple Air Conditioner in various rooms, section and floors of the office with just a press of a button, thus removing the need to walk across the whole office and individually control each A/C.



Home

Out-of Home⁴ prepares owners to be welcomed home with a pre cooled living space of maximum cooling comfort by offering control of Air Conditioners from anywhere outside of home.

GO DAIKIN

Built-In WiFi: Ceiling Cassette- FCFC-A
 Optional WiFi: Ceiling Cassette – FFC-A, FCC-A,
 Ceiling Concealed: FDBC-A, FDMC-A, FDMFC-A, Ceiling Exposed: FHC-A



Functions

- Start/stop operation
- Set operation mode
- Set room temperature
- Set fan speed
- Set airflow direction³
- Monitor current room temperature⁴
- Countdown timer⁴
- Error code
- User sharing
- Set weekly timer⁴
 - Start/stop operation
 - Operation mode and room temperature (maximum of six actions per day, 42 actions in total)

Required for Operation:

Network Adaptor AWM61A01 + Android™ Phone or iPhone + GO DAIKIN App (free) + Wireless Router + Internet

Available At:

Download on the App Store (iOS 9.0 or above) | GET IT ON Google Play (Android 5.0 or above) | EXPLORE IT ON AppGallery (Android 5.0 or above)

3 Simple Steps For Unit Pairing

STEP 1
 Download GO DAIKIN App

STEP 2
 Locate the QR Code (beside MCMC label) sticker on your warranty card or inside the WiFi Adaptor box, and scan it to pair your AC with your smartphone.

STEP 3
 Voila! You can now control your AC from your smartphone

Scan QR code to see GO Daikin setup video

Enjoy 2 Years Free*¹ Upgrade To Pro On Us

Function List	Standard RM0.00	Pro RM11.99 Per year
Standard Control Functions* ²	✓	✓
User Control Sharing to Family & Friends	✓	✓
In-Home AC Control	✓	✓
Out-Of-Home AC Control		✓
Indoor/Outdoor Temperature Monitoring		✓
Energy Usage Monitoring* ³		✓
Weekly Scheduling		✓
Countdown Timer		✓
Auto Error Code Detection	✓	✓
Voice Control (Alexa, Google Home)	✓	✓

GO DAIKIN APP:

- For compatible AC models list, please refer to Daikin Smart Control website page.
- A network adaptor (AWM61A01) is required for each indoor unit to use Smart Control function.
- Additional network adaptor is optional for compatible Non Built-In models (refer to i).
- An Internet connection through mobile data or WiFi network is required to use Smart Control function.
- Connectivity of App to AC will depend on the effective coverage area of your Local Area Network (LAN).
- This device supports DHCP (Dynamic Host Configuration Protocol) only. Ensure that your router has DHCP server option function activated before pairing.
- The controllable functions and features may differ depending on the model.

Smart Control Subscription:

- Free 2 years upgrade to Smart Control Pro upon first time successful pairing to network adaptor (AWM61A01). Package will switch back to Smart Control Standard (FREE) after 2 years. User can choose to upgrade to Smart Control Pro with subscription of RM 11.99 yearly per air conditioner.
- Function includes: On/Off, Operation Mode, Fan Swing, Fan Speed, Powerful Mode, Quiet Mode, Sleep Mode.
- Only applicable to certain Inverter models only. Please refer to Daikin website page for compatible model list.



Smarter Control, Voice Control.

Enjoy a smarter and more effortless way of controlling your Daikin Air Conditioning using voice control. Multi-task your way through the day by simply saying the commands to your Amazon Alexa or Google Home device while doing your daily tasks.

Just say the words

Hey Google, ask GO DAIKIN to switch On Living Room.

Alexa, ask GO DAIKIN to set Bedroom temperature to 24.

Hey Google, ask GO DAIKIN to turn on Eco mode for Kids Room.

* Full command list is available on the GO DAIKIN app.

Setup for Voice Control

Google Home/Nest Devices

Amazon Alexa Devices

Scan to view setup guide

Scan to view setup guide

Cassette Air Conditioner delivers cooling comfort evenly to every corner of the room

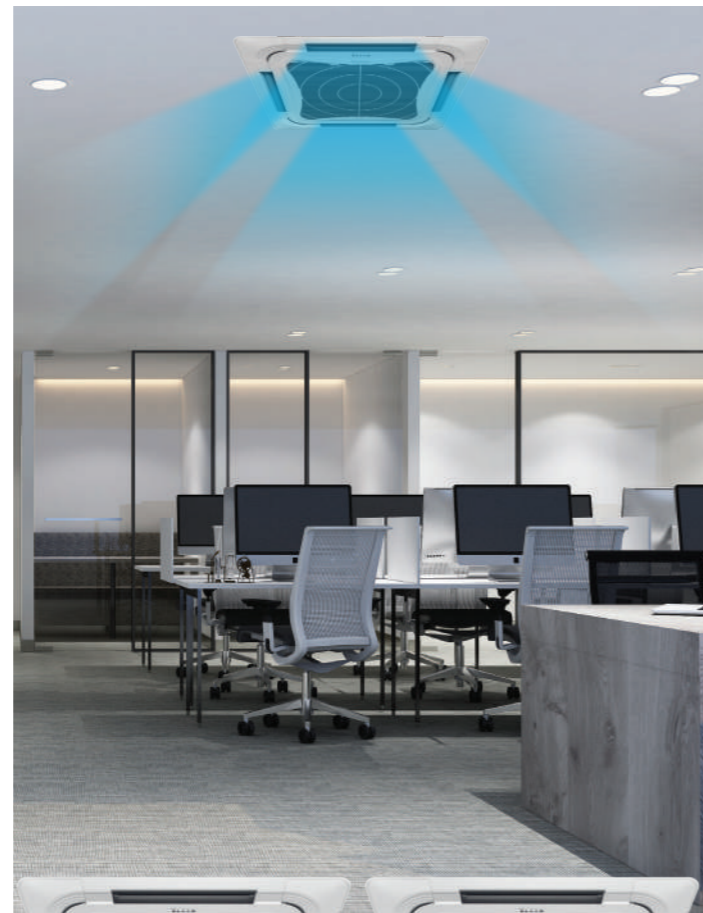

Non-Inverter
FFC25/35AV1M0



Inverter
FCFC50-140AV1MF



Non-Inverter
FCC50-140AV1M



DGS01

Compact Wireless Remote Controller

- Supplied together with panel for user convenience.
- Prominent temperature display.
- Real-time clock display.
- Easily accessible buttons.



DSL8

Slim Wired Remote Controller (Optional)*

- Dedicated button for Quiet and Turbo functions.
- Key lock function.
- Real-time timer. (7 days option, 2 events daily).
- Comes with 10m wired cable



BRC51D61

SHIRO Wired Remote Controller (Optional)*

- Better external outlook with glossy finishing.
- Display with backlight for better viewing.
- Room temperature indication.
- Comes with 10m wired cable

Product Features

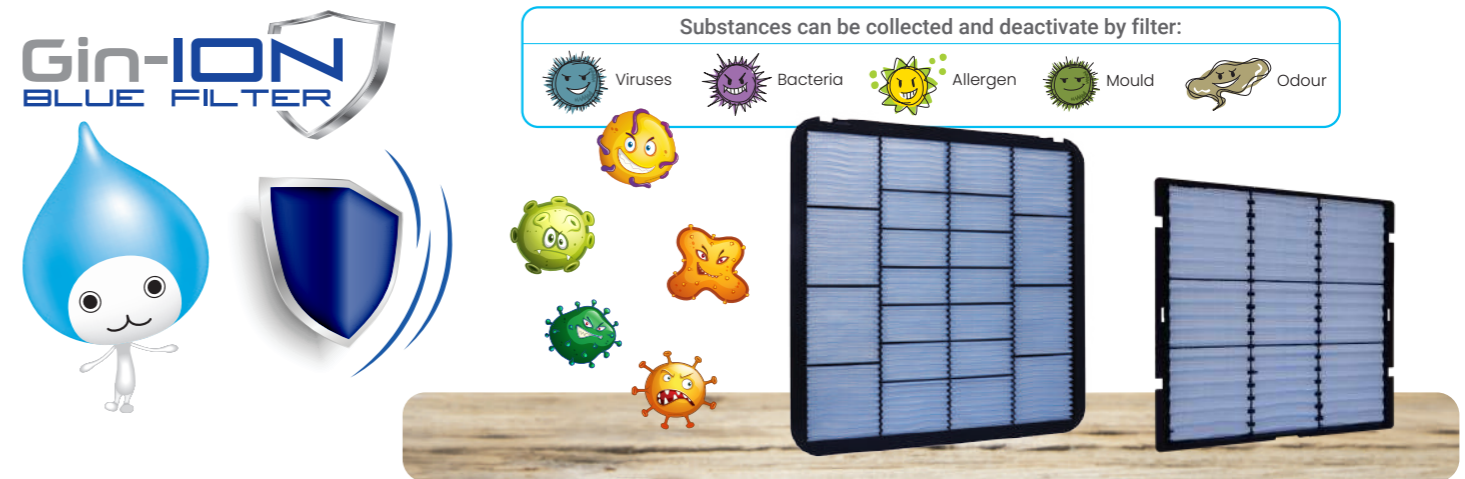

Gin ION Blue Filter

- This filter is treated with a positively charged silver ion (supplied as standard for FCFC, FFC and FCC).
- Efficiently draws viruses onto its surface and decomposes up to 99.9%* in 2 hours.
 - Deactivate bacteria and inhibit fungal growth on its surface to improve the quality of indoor air for a healthier lifestyle.
 - Delivers consistent performance for around a year if filter is cleaned once every 2 weeks.
- * The effect stated here is effect against viruses which are directly attached on the filter in the experimental facility for 2 hours.

Gin-ION Blue Filter Test Result

The Gin-ION Blue Filter has been tested and confirmed to decompose viruses, bacteria, and inhibit fungal growth on the filter surface.

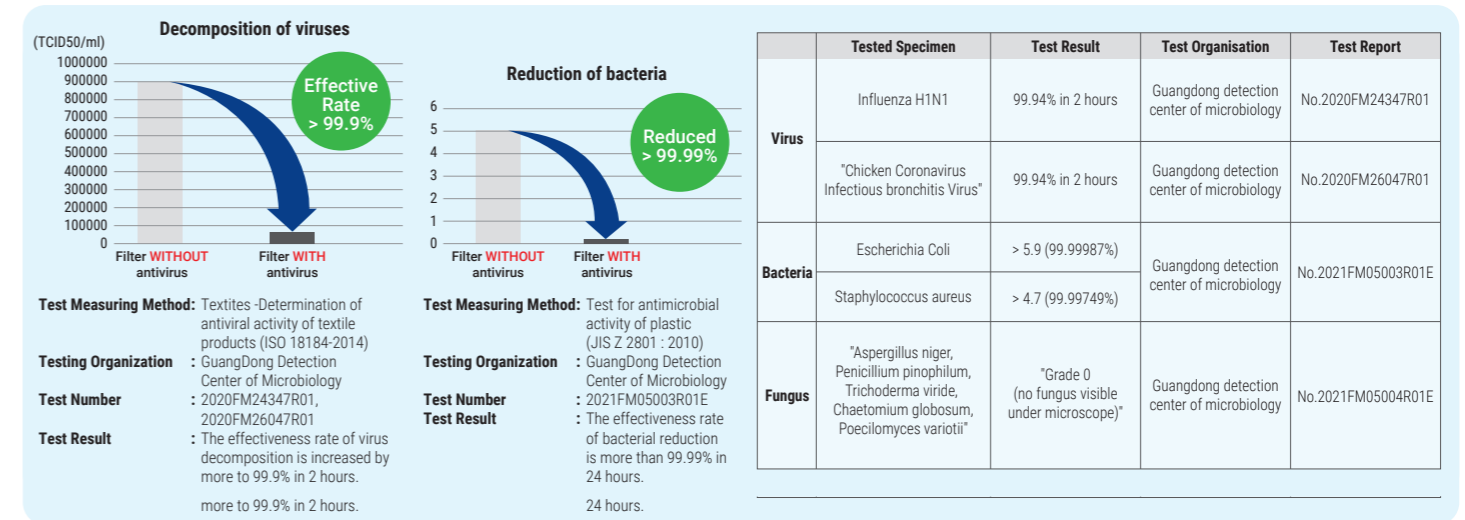

Better Indoor Air Quality

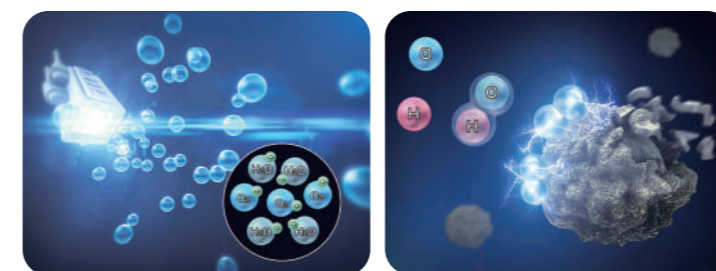

Advanced i-Plasma Technology

Our advanced plasma ion technology purifies and sterilizes the air by effectively removing airborne contaminants, as well as deactivating harmful bacteria by damaging their microbial DNA and surface structures without causing harm to human."

* Only for Non-Inverter models

Inspired by nature

Elegant Design Panel

Inspired by Nature. Combining with "butterfly" concept into modern ceiling cassette panel design to provide user a totally different outlook which match into current living lifestyle.



Malaysia
Good design
Daikin Ceiling Cassette has won the Malaysia Good Design Award 2015 in recognition of product design excellence, innovation and creativity.

Cassette Panel

Intake Grille

Smart Control



GO DAIKIN



AWM61A01

This built-in network adaptor together with "GO DAIKIN" app turns a smartphone into a remote controller that can be used inside or outside the home. Together, they help to not only save energy and maintain comfort but also eliminate any worries of forgetting to turn off your air conditioner!

Note: Certain app functions are optional.
Built-In WiFi - Inverter (FCFC-AV1MF),
Optional WiFi - Non-Inverter (FCC-AV1M0, FCC-AV1M8)



Low Height and New Design for Flexible Application



Non-Inverter - FDBC25/35AV1M

Inverter - FDMFC50-140AV1M

Non-Inverter - FDMC50-140AV1M



DSL8

Slim Wired Remote Controller

- Dedicated button for Quiet and Turbo functions.
- Key lock function.
- Real-time timer. (7 days option, 2 events daily).
- Comes with 10m wired cable



BRC51D62

SHIRO Wired Remote Controller (Optional)

- Better External Outlook with Glossy Finishing.
- Display with Backlight for better viewing.
- Room temperature indication.
- Comes with 10m wired cable.

Design And Installation Flexibility (For 50-160 Series Only)

Extreme Low Height Of Units

Installation is possible even in buildings with narrow ceiling spaces.

Series	50/60	85	100/125/140/160
Height (mm)	250	250	250
Width (mm)	700	1,000	1,400
Depth (mm)	700	700	700



Convertible Return Air Configuration

Easy conversion from rear return to bottom return is possible to be done on new ceiling concealed to fit in according to building structures.

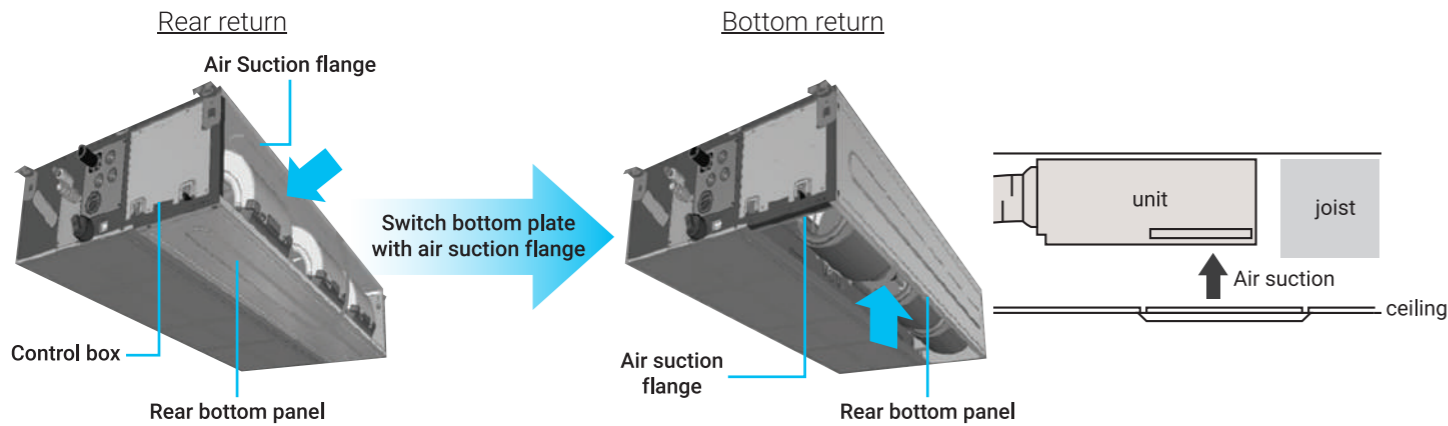

Comfort

Switchable Fan Speed: 3 Steps And Auto

- Control of fan speed up to 3-step.
- The unit has up to 3 different fan speed available for comfort selection.

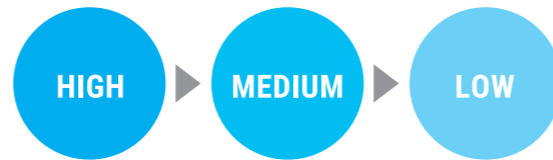

Easy Selectable External Static Pressure (ESP) (For 50-160 Series Only)

- 2-different ESP can be easily selected by switching the connector inside the control box as shown below.
- According to duct design required for comfort, the adjustment can be done easily during installation at the control box.

Series	50	60	85	100	120	140	160
Preset ESP (Pa)	30	30	30	50	50	50	50
Changeable ESP (Pa)	50	50	50	80	80	80	60

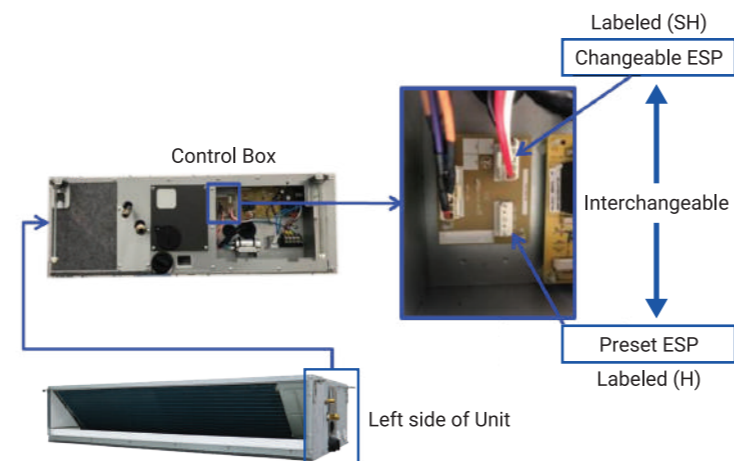

What is ESP (External Static Pressure)

External Static Pressure is the measurement of the total resistance in a duct system that the fan has to work against.

Easy Service Maintenance (For 50-160 Series Only)

Easy Accessible to Drain Pan and Heat Exchanger

- Drain Pan and Coil can be easily accessible by removing front bottom panel and mid flange.
- Followed by steps as shown below, coil can be accessed once drain pan is removed.

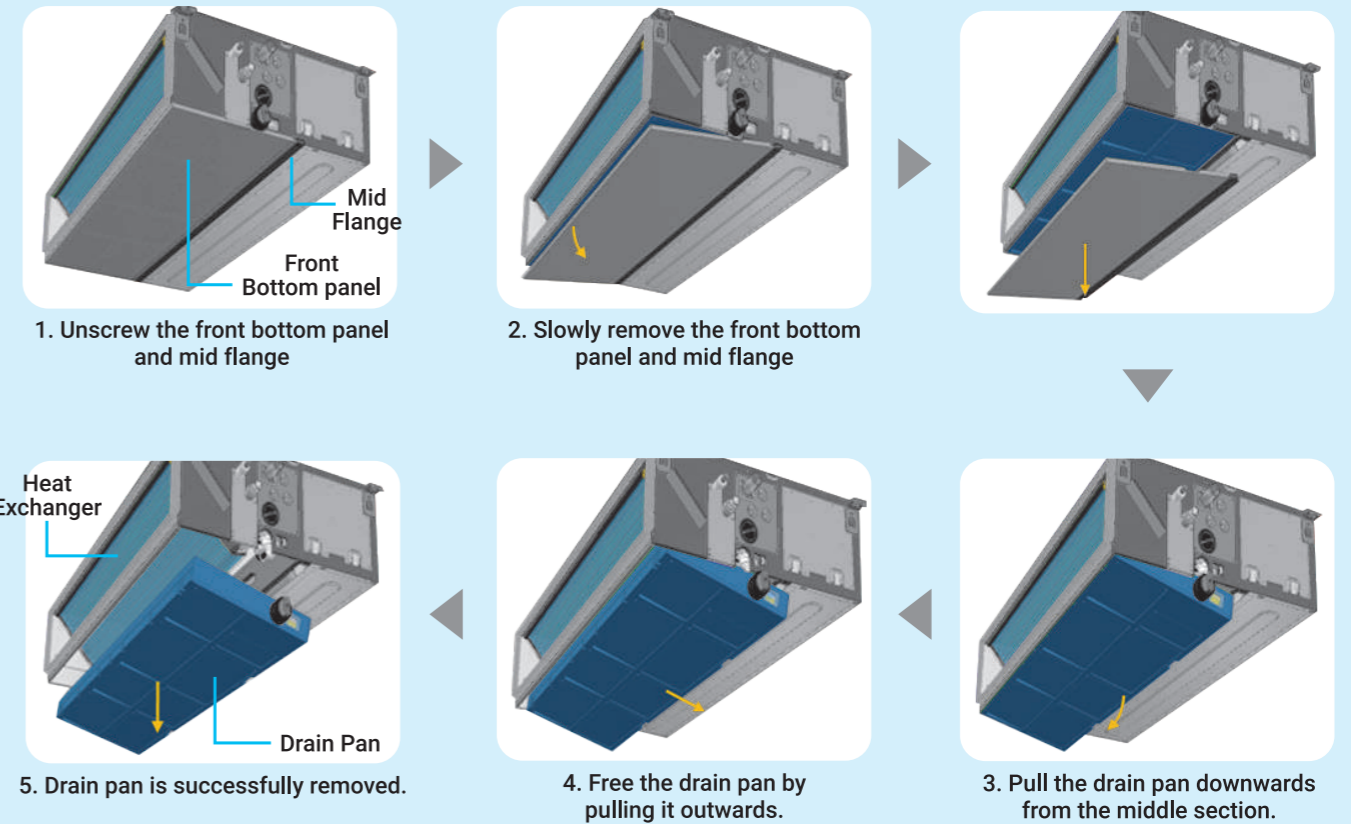

Optional Accessories

Drain Pump Is Ready For Installation

- Drain pump is optional accessory for new ceiling concealed.
- If Drain Pump is required, it could be purchased as accessories and installed at the designated location of the unit.

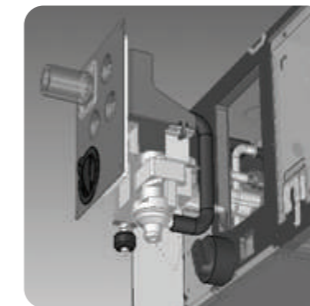

Saranet Filter

- Functions as dust filtration to trap dust in the air.



Part Number: R03084037810 (FDBC25A), R03084037811 (FDBC35A)
3P557870-1 (50-60 Series), 3P557868-1 (71-85 Series)
3P557863-1 (100-160 Series)

Smart Control (Optional)



NS Splitter (R50044157819)

This optional NS splitter comes with a network adaptor and together with "GO DAIKIN" app turns a smartphone into a remote controller that can be used inside or outside the home. Together, they help to not only save energy and maintain comfort but also eliminate any worries of forgetting to turn off your air conditioner!

Note: Certain app functions are optional.

- NS Splitter is applicable for all wired models for FCC-A, FCC-A, FDBC-A, FDMC-A, FHC-A, FCFC-A and FDMFC-A

Maximum air flow, providing cooling to far ends of the room



Non-Inverter FHC50-140AV1M



DGS01

Compact Wireless Remote Controller

- Supplied together for user convenience.
- Prominent temperature display.
- Real-time clock display.
- Easily accessible buttons.



DSLM8

Slim Wired Remote Controller (Optional)

- Dedicated button for Quiet and Turbo functions.
- Key lock function.
- Real-time timer. (7 days option, 2 events daily).
- Comes with 10m wired cable



BRC51D61

SHIRO Wired Remote Controller (Optional)

- Better external outlook with glossy finishing.
- Display with backlight for better viewing.
- Room temperature indication.
- Comes with 10m wired cable

Easy Service Maintenance

Switchable Fan Speed: 3 Steps And Auto

- High setting provides maximum reach.
- Low setting minimises draft.

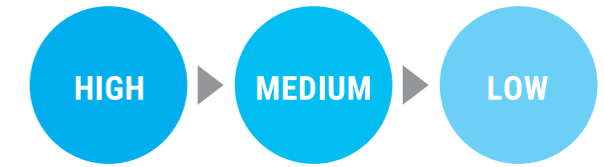

Horizontal And Vertical Air Swing

Airflow direction can be adjusted flexibly through horizontal and vertical louvers manually.

Far Air Throw

Maximum air throw distance up to 16.5m. (For 160 series)

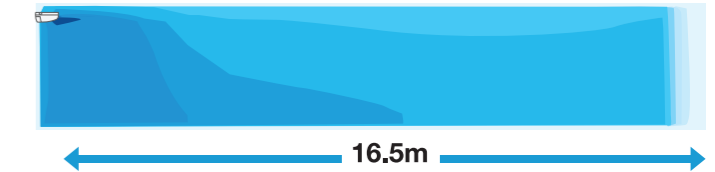

Easy Service Maintenance

Air Return Grille

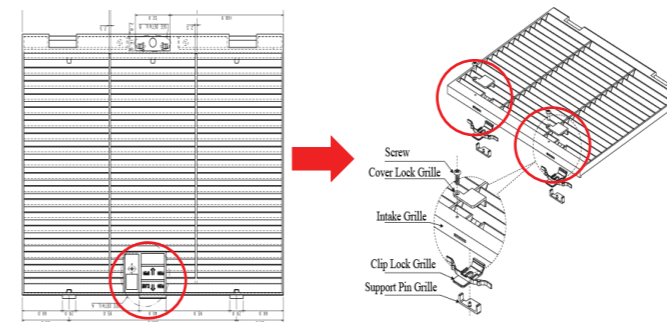

New Design - Easy to lock/unlock

Auto Random Restart With Last-State-Memory

- Once power resumes after a blackout, the unit will restart automatically at its last setting condition.
- This eliminates the need to restart manually after each power failure.

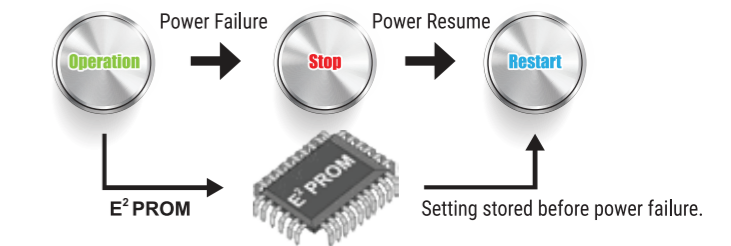

Smart Control (Optional)



This optional network adaptor together with "GO DAIKIN" app turns a smartphone into a remote controller that can be used inside or outside the home. Together, they help to not only save energy and maintain comfort but also eliminate any worries of forgetting to turn off your air conditioner!

Note: Certain app functions are optional.

Design And Installation Flexibility

Installation Flexibility For Freedom Of Design

Uniform height and depth. Compact design for small-capacity models to meet tighter dimensional constraints.

Series	50/60	85	100/125/140	160
Height (mm)	235	235	235	285
Width (mm)	1,203	1,553	1,903	1,903
Depth (mm)	680	680	680	680



680mm

New OUTDOOR Features



Inverter

Anti-Corrosion Treatment of Outdoor Heat Exchanger Fins

Comes with standard gold fin heat exchanger (RZFC50-71A) and aluminium alloy microchannel heat exchanger (RZFC85-140A).

Micro channel coil

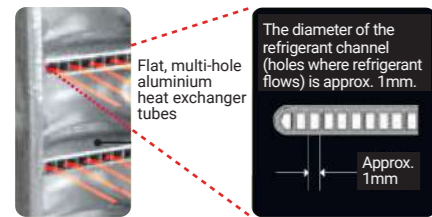

Flow of refrigerant

Refrigerant Cooling (RZFC125-140 only)

Daikin's unique refrigerant cooling system helps to protect the printed circuit board and maintains high cooling capacity even during high outdoor temperatures.

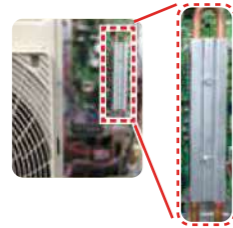

Coated Printed Circuit Boards (PCB)

Coated PCB prevent problems caused by humidity and airborne dust. It also protects against salt contained in sea breezes. Both side of the PCB in outdoor units are coated.



Non- Inverter

Anti-Corrosion Treatment of Outdoor Heat Exchanger Fins

Comes with standard blue fin outdoor unit's heat exchanger which are processed using a special anti-corrosion treatment. The surface is covered with a thin acrylic resin layer to enhance the fins' resistance to salt corrosion. Higher Corrosion Resistance Gold Fin is available (Optional)



Longer Piping Length

Series	Max Piping Length (m)	Max Piping Elevation (m)
25	25	15
35	25	15
50	35	20
60	35	20
85	50	30
100	50	30
125	50	30
140	50	30
160	50	30

* Improved piping length to provide installation flexibility

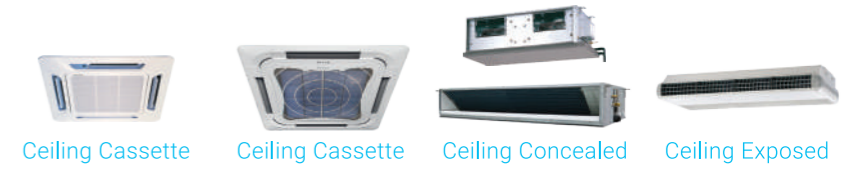
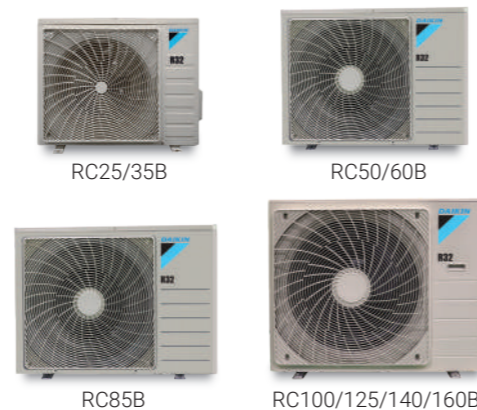

Technology	Inverter	Non-Inverter	Ceiling Cassette	Ceiling Cassette	Ceiling Concealed	Ceiling Exposed
Comfort Airflow	1 4-way Airflow Operation	●	●	●	●	●
	2 8-way Airflow Operation	●	●	●	●	●
	3 Auto Fan Speed	● 3 step	● 4 step	● 3 step	● 3 step	● 3 step
	4 Indoor Unit Quiet Operation	●	●	●	●	●
	5 Auto Swing	●	●	●	●	●
	6 Powerful Mode	●	●	●	●	●
Operation	7 Program Dry Function	●	●	●	●	●
	8 Fan Only	●	●	●	●	●
Lifestyle Convenience	9 Indoor Unit ON/OFF Button	●	●	●	●	●
	10 Signal Receiving Sign	●	●	●	●	●
	11 R/C With Back Light (SHIRO)	Optional	Optional	Optional	Optional	Optional
Cleanliness	12 Gin ION Blue Filter	●	●	●	●	●
	13 Saranet Filter	●	●	●	●	●
	14 i-Plasma	●	● (Non-Inverter Only)	●	●	●
	15 Washable Grille	●	●	●	●	●
Worry Free (Reliability & Durability)	16 Auto - Restart (After Power Failure)	●	●	●	●	●
	17 Self-Diagnosis (RIC, LED)	●	●	●	●	●
	18 Wiring Error Check Function	●	●	●	●	●
	19 Outdoor Blue Fin	●	● (Non-Inverter Only)	●	●	●
	20 Outdoor Gold Fin	Optional	● (Inverter 50-71) Optional: Non-Inverter	● (Inverter 50-71) Optional: Non-Inverter	● (Inverter 50-71) Optional: Non-Inverter	Optional
21 Outdoor Microchannel	●	● (Inverter 85-140)	● (Inverter 85-140)	● (Inverter 85-140)	●	
Flexibility	22 ESP Selection	●	●	●	●	●
	23 Water Pump (Water Drainage Pipe Flexibility)	●	●	●	●	●
	24 F/°C Change over R/C Temperature Display (Factory Setting: °C)	●	●	●	●	●
	25 WEEKLY TIMER (Wired Controller)	●	●	●	●	●
Remote Control	26 24-Hour ON/OFF TIMER	●	●	●	●	●
	27 NIM Adaptor	Optional	Optional	Optional	Optional	Optional
	28 Sequential NIM Adaptor	Optional	Optional	Optional	Optional	Optional
	29 Network Adaptor (Smart Control) for Wireless Model	Optional	● Build-In(Inverter) Optional: Non-Inverter	Optional*6	Optional	Optional
	30 Wireless	●	●	Optional*2	●	●
	31 Wired	Optional*3	Optional*4	●	Optional*5	Optional*5

- Not Available
 ● Standard
 *1 Only applicable for Series FDMC50-160A and FDMFC50-140A
 *2 Optional and requires the purchase of both wireless controller and wired controller in order to function.
 *3 Optional wired controller needs to be additionally purchased. When wired controller is installed, it will replace the network adaptor connection, removing smart control function.
 *4 Wired spec model does not come with built-in network adaptor. If wired controller is added to wireless built-in network adaptor model, it will replace the network adaptor connection, removing smart control function.
 *5 Optional and if unit installed with optional network adaptor, when wired controller is installed, it will replace the network adaptor connection, removing smart control function.
 *6 This model comes with standard Wired controller. Optional NS Splitter (R50044157819) is required to be purchased in order to function.

Comfort Airflow

8 Way Airflow

Discharge of air in 8 directions provides an even air distribution and fast cooling

Auto Fan Speed

Airflow rate is automatically controlled in accordance with the difference between room temperature and set temperature.

Auto Swing

Delivers comfortable air-conditioning to all areas, near to and far from the air conditioner. Airflow direction can be fixed at user's desired angle by remote controller.

Indoor Quiet Operation

Reduce background noise with Quiet Mode, which decreases the sound pressure level by setting fan speed to lowest.

Powerful Mode

Once activated, this feature will engage the indoor fan motor to run at maximum speed for 20 minutes. The turbo airflow enables the desired temperature to be achieved faster, especially in larger spaces.

Operation

Program Dry Function

Dehumidification is microprocessor controlled to prevent abrupt and uncomfortable changes in air temperature. Useful for reducing uncomfortable humidity without uncomfortable cooling of the room.

Fan Only

Unit will only operate with fan which provides airflow without supply of cool air.

Lifestyle Convenience

Indoor Unit ON/OFF Button

Unit can be switched on by pressing physical ON/OFF button on unit.

Signal Receiving Sign

Indication can be seen when air conditioner is switched on.

Remote Controller With Back Light

Lit up display for SHIRO wired controller allows user to use in the dark.

Cleanliness

Gin ION Blue Filter

Filter that deactivates bacteria and inhibit fungal growth and able to trap dust in the air.

Saranet Filter

Filter functions as standard dust filtration to trap dust in the air.

i-Plasma

Our advanced plasma ion technology purifies and sterilizes the air by effectively removing airborne contaminants, as well as deactivating harmful bacteria by damaging their microbial DNA and surface structures without causing harm to human.

Washable Grille

Ceiling Cassette grille can be detached easily and washed.

Worry Free

Auto-Restart With Surge Protection

If there is a sudden power failure, the unit will automatically restart with 64 different recovery patterns according to its last settings. This also prevents a sudden surge of electricity to your power source.

Self – Diagnosis Function

This intelligent feature helps to detect faults of malfunctioning in the system. Warning can be found through display error code in wired LCD remote controller. This information can be found in Installation Manual.

Wiring Error Check Function

Protection to prevent wrong wiring connection for 3 phase models.

Outdoor Blue Fin

Blue fin offers enhanced resistance of outdoor fin towards corrosion.

Outdoor Gold Fin

Gold fin offers higher corrosion resistance than blue fin.

Outdoor Microchannel

Corrosion resistant full aluminium alloy microchannel heat exchanger.

Flexibility

ESP Selection

2-different ESP can be easily selected by switching the connector inside the control box. According to duct design required for comfort, the adjustment can be done easily during installation at control box.

Water Pump

High head drain pump of 700mm that enables higher elevation.

°F/°C Changeover

Set temperature can be set to °F or °C on remote controller.

Control

WEEKLY TIMER (Wired Controller)

Up to five operation ON/OFF settings and temperature settings can be programmed per day and each day of the week.

24-Hour ON/OFF TIMER

Operation starts when the preset time of ON timer elapses and stops when preset time of the OFF timer elapses.

NIM Adaptor

Group control by Network Interface module (NIM) for simultaneous control of up to 16 indoor units.

S-NIM

Sequential control by Sequential Network Interface Module (S-NIM) for sequential control of 2 indoor units at alternate sequence of pre-set hour.

Built-In Network Adaptor (Smart Control)

Pre-installed network adaptor that enables control of indoor units using mobile devices through GO DAIKIN app.

NS Splitter

Device that enables the use of wired controller and network adaptor to function together.

Inverter

Ceiling Cassette

Specifications



FCFC A-Series

Model	Indoor unit		FCFC50AV1MF	FCFC60AV1MF	FCFC71AV1MF	FCFC85AV1MF	
	Outdoor unit		RZFC50AGVMM	RZFC60AGVMM	RZFC71AGVMM	RZFC85AVMM	
	Decoration panel	Wireless	BCR50FMF	BCR50FMF	BCR50FMF	BCR50FMF	
Wired		BCR50FMW	BCR50FMW	BCR50FMW	BCR50FMW		
Rated Cooling Capacity (Min-Max)	Btu/h		18,500 (7,800-19,100)	20,500 (8,900-21,500)	24,200 (10,900-27,300)	30,000 (14,300-34,100)	
	kW		5.42 (2.30-5.60)	6.00 (2.60-6.30)	7.10 (3.20-8.00)	8.79 (4.20-10.00)	
Total Power	W		1,680	1,960	2,070	2,710	
Total Current	A		7.37	8.55	9.07	12.00	
CSPF	Wh/Wh		4.47	4.34	4.78	4.67	
Power supply	V/Ph/Hz		220-240/1/50	220-240/1/50	220-240/1/50	220-240/1/50	
Indoor	Airflow (H/M/L/Q)		CFM	890/760/620/490	890/760/620/490	890/760/620/490	890/760/620/490
	Sound Pressure Level (H/M/L/Q)		dBa	44/40/37/35	44/40/37/35	44/40/37/35	44/40/37/35
	Dimension (H x W x D)	Unit	mm	246 X 840 X 840	246 X 840 X 840	246 X 840 X 840	246 X 840 X 840
		With decoration panel	mm	305 X 950 X 950	305 X 950 X 950	305 X 950 X 950	305 X 950 X 950
	Unit Weight	Unit	kg	22	22	22	22
		With decoration panel	kg	27	27	27	27
Outdoor	Sound Pressure Level		dBa	52	52	52	53
	Dimension (H x W x D)		mm	615 X 845 X 300	615 X 845 X 300	615 X 845 X 300	695 X 930 X 350
	Unit Weight		kg	37	37	37	40
Pipe Connection Size	Liquid	mm	6.40	6.40	9.50	9.50	
Pipe Connection Size	Gas	mm	12.70	12.70	15.90	15.90	
Maximum Piping Length		m	30	30	30	30	
Maximum Piping Elevation		m	15	15	15	30	
Heat Insulation			Both Liquid & Gas Piping				

Model	Indoor unit		FCFC100AV1MF	FCFC125AV1MF	FCFC140AV1MF	
	Outdoor unit		RZFC100AVMM	RZFC125AY1M	RZFC140AY1M	
	Decoration panel	Wireless	BCR50FMF	BCR50FMF	BCR50FMF	
Wired		BCR50FMW	BCR50FMW	BCR50FMW		
Rated Cooling Capacity (Min-Max)	Btu/h		36,000 (17,100-38,200)	42,000 (19,500-47,800)	48,000 (21,200-52,900)	
	kW		10.55 (5.00-11.20)	12.31 (5.70-14.00)	14.07 (6.20-15.50)	
Total Power	W		3,470	4,215	5,455	
Total Current	A		15.30	6.48	8.38	
CSPF	Wh/Wh		4.68	4.29	4.10	
Power supply	V/Ph/Hz		220-240/1/50	380-415/3/50	380-415/3/50	
Indoor	Airflow (H/M/L/Q)		CFM	1,120/1,030/890/760	1,120/1,030/890/760	1,120/1,030/890/760
	Sound Pressure Level (H/M/L/Q)		dBa	48/46/43/40	48/46/43/40	48/46/43/40
	Dimension (H x W x D)	Unit	mm	288 X 840 X 840	288 X 840 X 840	288 X 840 X 840
		With decoration panel	mm	347 X 950 X 950	347 X 950 X 950	347 X 950 X 950
	Unit Weight	Unit	kg	25	25	25
		With decoration panel	kg	30	30	30
Outdoor	Sound Pressure Level		dBa	54	54	56
	Dimension (H x W x D)		mm	695 X 930 X 350	990 X 940 X 320	990 X 940 X 320
	Unit Weight		kg	40	62	62
Pipe Connection Size	Liquid	mm	9.50	9.50	9.50	
Pipe Connection Size	Gas	mm	15.90	15.90	15.90	
Maximum Piping Length		m	50	50	50	
Maximum Piping Elevation		m	30	30	30	
Heat Insulation			Both Liquid & Gas Piping			

Remarks:

- Due to product innovation, all specifications are subjected to change by the manufacturer without prior notice.
- All units are being tested and comply to ISO13253.
- Nominal cooling capacity are based on the conditions: 27°C DB / 19°C WB indoor and 35°C DB outdoor.
- Sound pressure levels are measured in anechoic chamber according to JIS C 9612 standard and JIS B 8616.
- During actual operation, sound pressure level will be higher as a result of room specification condition.
- Units are equipped with contactor for Direct On Line (DOL) field installation.

Inverter



FDMFC-A Series

Ceiling Concealed

Specifications

Model	Indoor unit		FDMFC50AV1M	FDMFC60AV1M	FDMFC71AV1M	FDMFC85AV1M	
	Outdoor unit		RZFC50AGVMM	RZFC60AGVMM	RZFC71AGVMM	RZFC85AVMM	
Rated Cooling Capacity (Min-Max)	Btu/h		18,500 (7,800-19,100)	20,500 (8,900-21,500)	24,200 (10,900-27,300)	30,000 (14,300-34,100)	
	kW		5.42 (2.30-5.60)	6.00 (2.60-6.30)	7.10 (3.20-8.00)	8.79 (4.20-10.00)	
Total Power	W		1,940	2,300	2,150	2,770	
Total Current	A		8.51	10.10	9.20	12.40	
CSPF	Wh/Wh		4.16	4.13	4.36	4.76	
Power supply	V/Ph/Hz		220-240/1/50	220-240/1/50	220-240/1/50	220-240/1/50	
Indoor	Airflow (H/M/L)	CFM	590/525/430	590/525/430	950/810/700	950/810/700	
	External Static Pressure (Std/High)	Pa	30/50	30/50	30/50	30/50	
	Sound Pressure Level (H/M/L)	dBA	40/37/34	40/37/34	41/38/35	41/38/35	
	Dimension (H x W x D)	Unit	mm	250 X 700 X 700	250 X 700 X 700	250 X 1,000 X 700	250 X 1,000 X 700
	Unit Weight	Unit	kg	24	24	31	31
Outdoor	Sound Pressure Level	dBA	52	52	52	53	
	Dimension (H x W x D)	mm	615 X 845 X 300	615 X 845 X 300	615 X 845 X 300	695 X 930 X 350	
	Unit Weight	kg	37	37	37	40	
Pipe Connection Size	Liquid	mm	6.40	6.40	9.50	9.50	
Pipe Connection Size	Gas	mm	12.70	12.70	15.90	15.90	
Maximum Piping Length		m	30	30	30	50	
Maximum Piping Elevation		m	15	15	15	30	
Heat Insulation	Both Liquid & Gas Piping						

Model	Indoor unit		FDMFC100AV1M	FDMFC125AV1M	FDMFC140AV1M	
	Outdoor unit		RZFC100AVMM	RZFC125AY1M	RZFC140AY1M	
Rated Cooling Capacity (Min-Max)	Btu/h		36,000 (17,100-38,200)	42,000 (19,500-47,800)	48,000 (21,200-52,900)	
	kW		10.55 (5.00-11.20)	12.31 (5.70-14.00)	14.07 (6.20-15.50)	
Total Power	W		3,520	4,680	5,390	
Total Current	A		15.60	7.23	8.24	
CSPF	Wh/Wh		4.59	3.98	4.38	
Power supply	V/Ph/Hz		220-240/1/50	380-415/3/50	380-415/3/50	
Indoor	Airflow (H/M/L)	CFM	1,260/1,095/920	1,260/1,095/920	1,260/1,095/920	
	External Static Pressure (Std/High)	Pa	50/80	50/80	50/80	
	Sound Pressure Level (H/M/L)	dBA	42/39/36	42/39/36	42/39/36	
	Dimension (H x W x D)	Unit	mm	250 X 1,400 X 700	250 X 1,400 X 700	250 X 1,400 X 700
	Unit Weight	Unit	kg	40	40	42
Outdoor	Sound Pressure Level	dBA	54	54	56	
	Dimension (H x W x D)	mm	695 X 930 X 350	990 x 940 x 320	990 x 940 x 320	
	Unit Weight	kg	40	62	62	
Pipe Connection Size	Liquid	mm	9.50	9.50	9.50	
Pipe Connection Size	Gas	mm	15.90	15.90	15.90	
Maximum Piping Length		m	50	50	50	
Maximum Piping Elevation		m	30	30	30	
Heat Insulation	Both Liquid & Gas Piping					

- Remarks:**
- Due to product innovation, all specifications are subjected to change by the manufacturer without prior notice.
 - All units are being tested and comply to ISO5151.
 - Nominal cooling capacity are based on the conditions: 27°C DB / 19°C WB indoor and 35°C DB outdoor.
 - Sound pressure levels are measured in anechoic chamber according to JIS C 9612 standard and JIS B 8616. During actual operation, sound pressure level will be higher as a result of room specification condition.
 - Units are equipped with contactor for Direct On Line (DOL) field installation.

Non-Inverter



FFC-A Series



FCC-A Series

Ceiling Cassette

Specifications

Model	Indoor unit		FFC25AV1M0	FFC25AV1M0	FCC50AV1M8	FCC60AV1M8	
	Outdoor unit		RC25BV1M	RC35BV1M	RC50BV1M	RC60BV1M	
	Decoration panel	Wireless	BF20CBM0	BF20CBM0	BC50FBM0	BC50FBM0	
Wired		-	-	BC50FBMW	BC50FBMW		
Rated Cooling Capacity	Btu/h		9,500	12,500	18,500	24,000	
	kW		2.78	3.66	5.42	7.03	
Total Power	W		927	1,115	1,680	2,130	
Total Current	A		4.10	4.94	7.46	9.45	
COP	W/W		3.00	3.29	3.23	3.30	
CSPF	Wh/Wh		3.19	3.49	3.43	3.50	
Power supply	V/Ph/Hz		220-240/1/50	220-240/1/50	220-240/1/50	220-240/1/50	
Indoor	Airflow (H/M/L/Q)	cfm	410/360/330	410/360/330	840/700/560/440	890/760/620/490	
	Sound Pressure Level (H/M/L/Q)	dBA	41/38/35	41/38/35	42/39/37/35	44/40/37/35	
	Dimension (H x W x D)	Unit	mm	250 x 570 x 570	250 x 570 x 570	246 X 840 X 840	246 X 840 X 840
		With decortion panel	mm	316 x 630 x 630	316 x 630 x 630	305 X 950 X 950	305 X 950 X 950
	Unit Weight	Unit	kg	15.5	15.5	22	22
With decortion panel		kg	17.5	17.5	27	27	
Outdoor	Sound Pressure Level	dBA	46	48	52	52	
	Dimension (H x W x D)	mm	550 X 658 X 273	550 X 658 X 273	615 X 845 X 300	615 X 845 X 300	
	Unit Weight	kg	25	28	40	46	
Pipe Connection Size	Liquid	mm	6.35	6.35	6.35	6.35	
Pipe Connection Size	Gas	mm	9.52	9.52	12.70	12.70	
Maximum Piping Length		m	25	25	35	35	
Maximum Piping Elevation		m	15	15	20	20	
Heat Insulation	Both Liquid and Gas Piping						

Model	Indoor unit		FCC85AV1M8	FCC100AV1M8	FCC125AV1M8	FCC140AV1M8	
	Outdoor unit		RC85BV1M	RC100BV1M	RC125BY1M	RC140BY1M	
	Decoration panel	Wireless	BC50FBM0	BC50FBM0	BC50FBM0	BC50FBM0	
Wired		BC50FBMW	BC50FBMW	BC50FBMW	BC50FBMW		
Rated Cooling Capacity	Btu/h		30,000	36,000	42,000	48,000	
	kW		8.79	10.55	12.31	14.07	
Total Power	W		2,710	3,150	3,620	4,100	
Total Current	A		12.10	14.30	6.78	7.59	
COP	W/W		3.24	3.35	3.40	3.43	
CSPF	Wh/Wh		3.44	3.56	3.61	3.64	
Power supply	V/Ph/Hz		220-240/1/50	220-240/1/50	380-415/3/50	380-415/3/50	
Indoor	Airflow (H/M/L/Q)	cfm	890/760/620/490	1,120/1,030/890/760	1,120/1,030/890/760	1,120/1,030/890/760	
	Sound Pressure Level (H/M/L/Q)	dBA	44/40/37/35	48/46/43/40	48/46/43/40	48/46/43/40	
	Dimension (H x W x D)	Unit	mm	246 X 840 X 840	288 X 840 X 840	288 X 840 X 840	288 X 840 X 840
		With decortion panel	mm	305 X 950 X 950	347 X 950 X 950	347 X 950 X 950	347 X 950 X 950
	Unit Weight	Unit	kg	22	25	25	25
With decortion panel		kg	27	30	30	30	
Outdoor	Sound Pressure Level	dBA	54	56	58	60	
	Dimension (H x W x D)	mm	695 X 930 X 350	852 X 1,030 X 400	852 X 1,030 X 400	852 X 1,030 X 400	
	Unit Weight	kg	53	62	79	84	
Pipe Connection Size	Liquid	mm	9.52	9.52	9.52	9.52	
Pipe Connection Size	Gas	mm	15.88	15.88	15.88	15.88	
Maximum Piping Length		m	50	50	50	50	
Maximum Piping Elevation		m	30	30	30	30	
Heat Insulation	Both Liquid and Gas Piping						

- Remarks:**
- Due to product innovation, all specifications are subjected to change by the manufacturer without prior notice.
 - All units are being tested and comply to ISO5151.
 - Nominal cooling capacity are based on the conditions: 27°C DB / 19°C WB indoor and 35°C DB outdoor.
 - Sound pressure levels are measured in anechoic chamber according to JIS C 9612 standard and JIS B 8616. During actual operation, sound pressure level will be higher as a result of room specification condition.
 - RC100AV1M and RC125/140AY1M are equipped with contactor for Direct On Line (DOL) field installation.

Non-Inverter



FDBC-A Series

FDMC-A Series

Ceiling Concealed

Specifications

Model		Indoor unit		FDBC25AV1M	FDBC35AV1M	FDMC50AV1M	FDMC60AV1M
		Outdoor unit		RC25BV1M	RC35BV1M	RC50BV1M	RC60BV1M
Rated Cooling Capacity		Btu/h	9,000	12,000	18,500	23,500	
		kW	2.64	3.52	5.42	6.89	
Total Power		W	926	1,220	1,750	2,290	
Total Current		A	4.26	5.60	7.74	10.30	
COP		W/W	2.95	3.08	3.10	3.01	
CSPF		Wh/Wh	3.13	3.27	3.29	3.20	
Power supply		V/Ph/Hz	220-240/1/50	220-240/1/50	220-240/1/50	220-240/1/50	
Indoor	Airflow (H/M/L)		cfm	320/290/240	510/460/350	590/525/430	590/525/430
	External Static Pressure (Std/High)		Pa	10	10	30/50	30/50
	Sound Pressure Level (H/M/L)		dBA	32/30/26	36/33/29	40/37/34	40/37/34
	Dimension (H x W x D)	Unit	mm	261 x 765 x 411	261 x 905 x 411	250 X 700 X 700	250 X 700 X 700
	Unit Weight	Unit	kg	18	22	24	24
Outdoor	Sound Pressure Level		dBA	46	48	52	52
	Dimension (H x W x D)		mm	550 x 658 x 273	550 x 658 x 273	615 X 845 X 300	615 X 845 X 300
	Unit Weight		kg	25	28	40	46
Pipe Connection Size	Liquid	mm	6.35	6.35	6.35	6.35	
Pipe Connection Size	Gas	mm	9.52	9.52	12.70	12.70	
Maximum Piping Length		m	25	25	35	35	
Maximum Piping Elevation		m	15	15	20	20	
Heat Insulation	Both Liquid and Gas Piping						

Model		Indoor unit		FDMC85AV1M	FDMC100AV1M	FDMC125AV1M	FDMC140AV1M	FDMC160AV1M
		Outdoor unit		RC85BV1M	RC100BV1M	RC125BY1M	RC140BY1M	RC160BY1M
Rated Cooling Capacity		Btu/h	30,000	36,000	42,000	48,000	55,000	
		kW	8.79	10.55	12.31	14.07	16.12	
Total Power		W	2,770	3,200	3,660	4,100	4,950	
Total Current		A	12.40	14.80	6.85	7.51	8.73	
COP		W/W	3.17	3.30	3.36	3.43	3.26	
CSPF		Wh/Wh	3.37	3.50	3.57	3.64	3.46	
Power supply		V/Ph/Hz	220-240/1/50	220-240/1/50	380-415/3/50	380-415/3/50	380-415/3/50	
Indoor	Airflow (H/M/L)		cfm	950/810/700	1,260/1,095/920	1,260/1,095/920	1,260/1,095/920	1,400/1,280/1,120
	External Static Pressure (Std/High)		Pa	30/50	50/80	50/80	50/80	50/60
	Sound Pressure Level (H/M/L)		dBA	41/38/35	42/39/36	42/39/36	42/39/36	43/42/39
	Dimension (H x W x D)	Unit	mm	250 X 1,000 X 700	250 X 1,400 X 700	250 X 1,400 X 700	250 X 1,400 X 700	250 X 1,400 X 700
	Unit Weight	Unit	kg	31	40	40	42	44
Outdoor	Sound Pressure Level		dBA	54	56	58	60	62
	Dimension (H x W x D)		mm	695 X 930 X 350	852 X 1,030 X 400	852 X 1,030 X 400	852 X 1,030 X 400	852 X 1,030 X 400
	Unit Weight		kg	53	62	79	84	94
Pipe Connection Size	Liquid	mm	9.52	9.52	9.52	9.52	9.52	
Pipe Connection Size	Gas	mm	15.88	15.88	15.88	15.88	19.05	
Maximum Piping Length		m	50	50	50	50	50	
Maximum Piping Elevation		m	30	30	30	30	30	
Heat Insulation	Both Liquid and Gas Piping							

- Remarks:**
- Due to product innovation, all specifications are subjected to change by the manufacturer without prior notice.
 - All units are being tested and comply to ISO13253.
 - Nominal cooling capacity are based on the conditions: 27°C DB / 19°C WB indoor and 35°C DB outdoor.
 - Sound pressure levels are measured in anechoic chamber according to JIS C 9612 standard and JIS B 8616. During actual operation, sound pressure level will be higher as a result of room specification condition.
 - RC100AV1M and RC125/140AY1M are equipped with contactor for Direct On Line (DOL) field installation.

Non-Inverter



FHC-A Series

Ceiling Exposed

Specifications

Model		Indoor unit		FHC50AV1M	FHC60AV1M	FHC85AV1M
		Outdoor unit		RC50BV1M	RC60BV1M	RC85BV1M
Rated Cooling Capacity		Btu/h	18,500	23,500	29,500	
		kW	5.42	6.89	8.65	
Total Power		W	1,785	2,220	2,860	
Total Current		A	8.05	9.88	12.80	
COP		W/W	3.04	3.10	3.02	
CSPF		Wh/Wh	3.23	3.29	3.21	
Power supply		V/Ph/Hz	220-240/1/50	220-240/1/50	220-240/1/50	
Indoor	Airflow (H/M/L)		cfm	620/600/490	620/600/490	830/730/625
	Sound Pressure Level (H/M/L)		dBA	47/46/43	47/46/43	48/45/42
	Dimension (H x W x D)	Unit	mm	235 X 1,203 X 680	235 X 1,203 X 680	235 X 1,553 X 680
	Unit Weight	Unit	kg	33	33	41
Outdoor	Sound Pressure Level		dBA	52	52	54
	Dimension (H x W x D)		mm	615 X 845 X 300	615 X 845 X 300	695 X 930 X 350
	Unit Weight		kg	40	46	53
Pipe Connection Size	Liquid	mm	6.35	6.35	9.52	
Pipe Connection Size	Gas	mm	12.70	12.70	15.88	
Maximum Piping Length		m	35	35	50	
Maximum Piping Elevation		m	20	20	30	
Heat Insulation	Both Liquid and Gas Piping					

Model		Indoor unit		FHC100BV1M	FHC125AV1M	FHC140AV1M	FHC160AV1M
		Outdoor unit		RC100BV1M	RC125BY1M	RC140BY1M	RC160BY1M
Rated Cooling Capacity		Btu/h	36,000	42,000	46,000	55,000	
		kW	10.55	12.31	13.48	16.12	
Total Power		W	3,250	3,860	4,300	5,500	
Total Current		A	14.70	7.14	7.93	9.62	
COP		W/W	3.25	3.19	3.14	2.93	
CSPF		Wh/Wh	3.45	3.39	3.33	3.11	
Power supply		V/Ph/Hz	220-240/1/50	380-415/3/50	380-415/3/50	380-415/3/50	
Indoor	Airflow (H/M/L)		cfm	1,125/1,030/960	1,125/1,030/960	1,125/1,030/960	1,460/1,390/1,150
	Sound Pressure Level (H/M/L)		dBA	52/50/48	52/50/48	52/50/48	55/53/50
	Dimension (H x W x D)	Unit	mm	235 X 1,903 X 680	235 X 1,903 X 680	235 X 1,903 X 680	285 X 1,903 X 680
	Unit Weight	Unit	kg	50	50	50	60
Outdoor	Sound Pressure Level		dBA	56	58	60	62
	Dimension (H x W x D)		mm	852 X 1,030 X 400	852 X 1,030 X 400	852 X 1,030 X 400	852 X 1,030 X 400
	Unit Weight		kg	62	79	84	94
Pipe Connection Size	Liquid	mm	9.52	9.52	9.52	9.52	
Pipe Connection Size	Gas	mm	15.88	15.88	15.88	19.05	
Maximum Piping Length		m	50	50	50	50	
Maximum Piping Elevation		m	30	30	30	30	
Heat Insulation	Both Liquid and Gas Piping						

- Remarks:**
- Due to product innovation, all specifications are subjected to change by the manufacturer without prior notice.
 - All units are being tested and comply to ISO5151.
 - Nominal cooling capacity are based on the conditions: 27°C DB / 19°C WB indoor and 35°C DB outdoor.
 - Sound pressure levels are measured in anechoic chamber according to JIS C 9612 standard and JIS B 8616. During actual operation, sound pressure level will be higher as a result of room specification condition.
 - RC100AV1M and RC125/140AY1M are equipped with contactor for Direct On Line (DOL) field installation.